

Product data sheet

Characteristics

8903LG60V02

Contactor, Type L, multipole lighting, electrically held, 30A, 6 pole, 600 V, 110/120 VAC 50/60 Hz coil, NEMA 1



Product availability: Stock - Normally stocked in distribution facility

Price*: 890.00 USD



Main

Product or Component Type	Electrically Held Lighting Contactor
Range of Product	8903L
Control circuit	Separate control circuit

Complementary

[Uc] control circuit voltage	110 V AC 50 Hz 120 V AC 60 Hz
Inrush power in VA	150 VA 60 Hz 140 VA 50 Hz
Hold-in power consumption in VA	30 VA 60 Hz 30 VA 50 Hz
Line Rated Current	20 A tungsten 30 A fluorescent
Poles description	6P 6 NO
Control type	No control units
Local signalling	No indicator
Electrical Connection	Screw-clamp terminals
Maximum Height	12.68 In (322 mm)
Maximum Depth	6.02 In (153 mm)
Maximum Width	7.80 In (198 mm)
Net Weight	10.14 Lb(US) (4.6 kg)

Environment

NEMA degree of protection	NEMA 1 painted sheet steel surface
Product Certifications	UL Listed CSA

Ordering and shipping details

Category	21321 - 8903 L (NOT LX)
Discount Schedule	CP1
GTIN	00785901851400
Nbr. of units in pkg.	1
Package weight(Lbs)	9.94 Lb(US) (4.51 kg)
Returnability	Yes
Country of origin	MX

Packing Units

Unit Type of Package 1	PCE
Package 1 Height	7.40 In (18.8 cm)
Package 1 width	8.39 In (21.3 cm)
Package 1 Length	13.70 In (34.8 cm)

Offer Sustainability

Sustainable offer status	Green Premium product
REACH Regulation	REACH Declaration
REACH free of SVHC	Yes
EU RoHS Directive	Compliant EU RoHS Declaration
Toxic heavy metal free	Yes
Mercury free	Yes
RoHS exemption information	Yes
China RoHS Regulation	China RoHS Declaration
Environmental Disclosure	Product Environmental Profile
PVC free	Yes
Halogen content performance	Halogen free plastic parts product

Contractual warranty

Warranty	18 months
----------	-----------

Approximate Dimensions

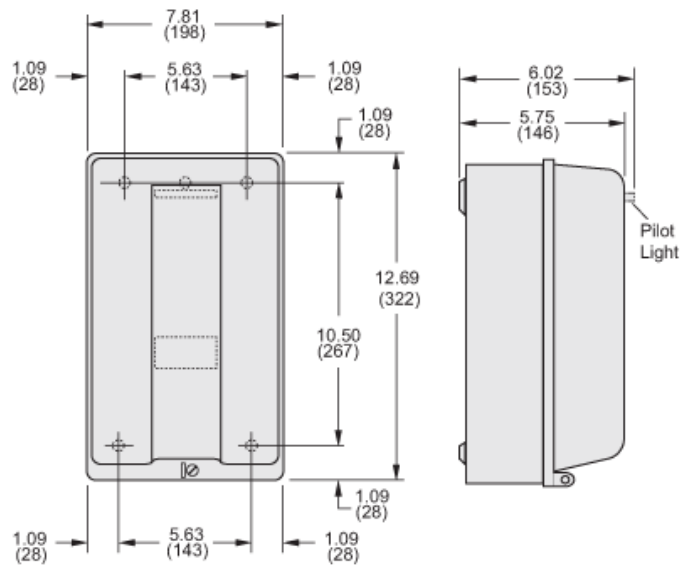

Product Life Status : Commercialised